

Submitted Model No.: _____

Specific Features: _____

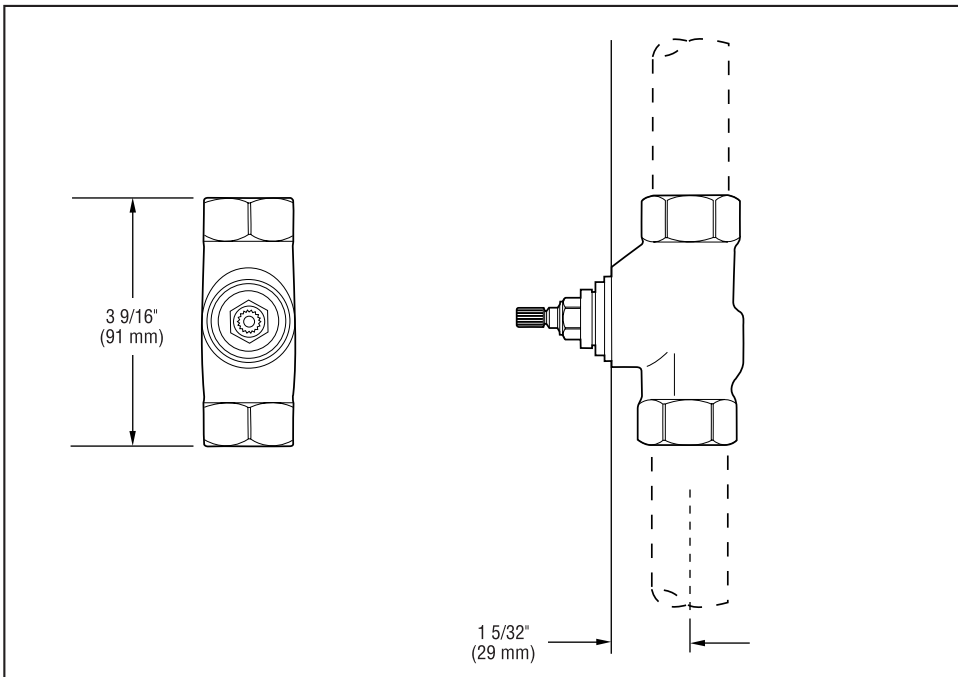

BRIZO®

3/4" VOLUME CONTROL

- 24 GPM @ 45 PSI
- Recommended Working Pressure 45-80 PSI
- Maximum Hot Water Temperature 176°F

STANDARD SPECIFICATIONS

- Solid brass body.
- 3/4" I.P.S. Inlets.
- RP34837 extension kit available when needed.













Lever & Cross Handles Only

COMPLIES WITH:

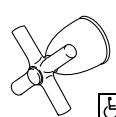
- ANSI/ASME A112.18.1 / CSA B125.1

AVAILABLE HANDLE OPTIONS FOR R66001:

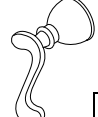
* DESIGNATE PROPER FINISH SUFFIX

<p>T66411* Metal Rope</p>  	<p>T66431* Metal Cross</p>  	<p>T66481* Cross</p>  	<p>T664601* Metal Lever</p>  	<p>T66471* French Lever</p>  
---	---	---	--	--

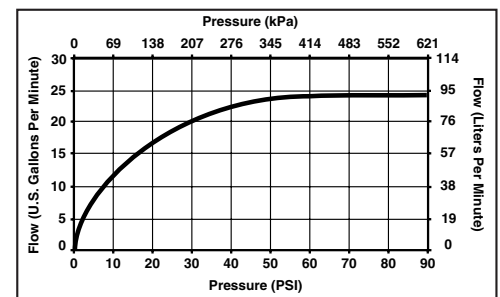

Delta Faucet Company
 Indianapolis, Indiana 46280
 A Division of Masco Corporation of Indiana
 © 2008 Masco Corporation of Indiana